

RICHMOND TOWNSHIP  
34900 School Section  
Richmond, MI 48062  
(586) 727-8998 Fax (586) 727-8997  
[www.richmondtp.org](http://www.richmondtp.org)

**REQUIREMENTS FOR POOLS  
ABOVEGROUND AND UNDERGROUND**

1. Building Permit Application.
2. Site plan showing the following:
  - a. All buildings on property, distance the pool is from all buildings and from lot lines.
  - b. Location of well, septic field and tank.
3. Pamphlet or brochure of pool showing what the pool is constructed of, the size and shape of the pool.
4. Pool must be enclosed by either a fence or deck according to ordinance.
5. If you live on Fox Creek or in Hidden Meadows, a letter of approval must be included from the Association.

**POOLS**

- Pools must be 10' from the septic tank or field.
- Pools cannot be located under overhead lines: Edison, telephone or cable.
- Check with Edison for underground wires for in-ground pools.
- If the pool is connected to a deck attached to the house, an alarm on the door for safety reasons must be installed, in accordance with the Michigan Building Code. You must also sign a pool alarm affidavit from the township.
- Fences: For the safety of your family and the community, fencing is required with some restrictions:
  - a. For aboveground pools, no fence required if the height of pool walls are 48" or higher, and the ladder needs to be able to flip up and latch on the inside to 54".
  - b. For inground pools a fence needs to be constructed around the perimeter of the pool with a gate to swing away from the pool and the latch on the inside of the gate.
- **NO FINAL BUILDING INSPECTION WILL BE COMPLETE UNTIL FENCING AROUND POOL IS COMPLETED IF REQUIRED.**

**Private Pools Section 7.00 from the Richmond Township Zoning Ordinance**  
**Subsection H**

**H. Private Pools**

Private pools shall be permitted as an accessory use within the rear yard only, provided they meet the following requirements:

1. Private pools shall not require Planning Commission review and approval.
2. The outside edge of the pool wall shall be set back from any side or rear lot line a distance at least equal to the side-yard setback as specified in the township in which the pool is located. In no instance shall this setback be less than ten (10) feet.
3. There shall be a distance of not less than ten (10) feet between the outside pool wall and any building located on the same lot.
4. No swimming pool shall be located in the front or street side yard.
5. No swimming pool shall be located in an easement.

**Amend Article 7 Residential Districts, by amending Section 7.00 Provisions Applicable to Residential Districts by adding a new subsection H. to read as follows:**

**H. Private Pools**

Private pools shall be permitted as an accessory use within the rear yard only, provided they meet the following requirements:

1. Private pools shall not require Planning Commission review and approval.
2. The outside edge of the pool wall shall be set back from any side or rear lot line a distance at least equal to the sideyard setback as specified in the District in which the pool is located. In no instance shall this setback be less than ten (10) feet.
3. There shall be a distance of not less than ten (10) feet between the outside pool wall and any building located on the same lot.
4. No swimming pool shall be located in the front or street side yard.
5. No swimming pool shall be located in an easement.
6. For the protection of the general public, all areas containing swimming pools shall be completely enclosed by a fence not less than four (4) feet in height. The gates shall be a self-closing and latching type, with the latch on the inside of the gate not readily available for children to open. Gates shall be capable of being securely locked when the pool is not in use for extended periods.

**EXAMPLE: STORABLE SWIMMING POOL**  
National Electrical Code

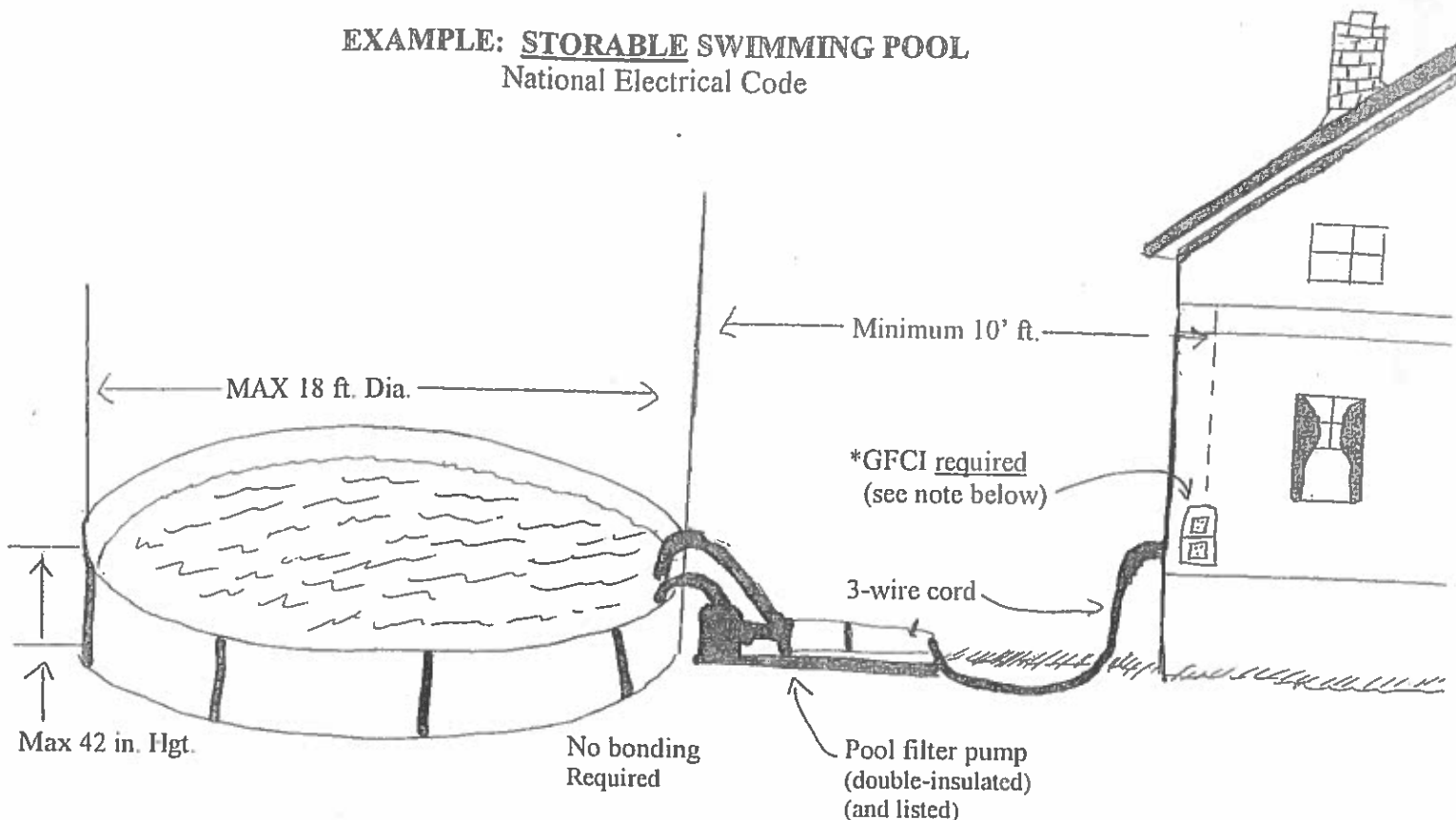

**Storable pools only.** The type of pump suitable for use with storable pools has a 25-foot flexible cord and attachment Plug. It is marked:

“This Pump is for Use with Storable Pools Only – DO NOT USE with Permanently Installed Pools. A storable pool is constructed so that it may be readily disassembled for storage and reassembled to its original integrity. A permanently installed pool is constructed in or on the ground or in a building such that it cannot be readily disassembled for storage.” Cords may NOT be shortened nor shall attachment caps be changed to a different type. If a listed double insulated pump motor comes with a shorter cord, the assembly must be located so that the cord will reach an electrical outlet at least ten feet away from the pool.

**General.** Underwater lighting fixtures for above ground storable pools are intended for temporary installation only through or on the wall of an above ground storable pool. UL considers a storable pool to be one that has a maximum diameter of 18 feet, a maximum wall height of 3 ½ feet, and lends itself to being readily disassembled and reassembled. These fixtures are intended to be installed with the top of the lens not less than eight nor more than 10 inches below the top of the pool wall unless the fixture is otherwise marked. These fixtures are provided with a minimum of 25 feet of jacketed flexible cord, which is intended to be routed away from the pool to the transformer assembly. The transformer assembly is intended to be temporarily mounted to a building structure and is provided with a minimum 3-foot/maximum 6-foot power supply cord for connection to the supply source. These fixtures are intended to be serviced from the outside of the pool.

**Listing Mark.** The UL Listing Mark for these products accompanies the product name “Underwater Lighting Fixture for Above Ground Storable Swimming Pool.”

### **Pumps**

**Listing Marks.** Pumps suitable for this application have a listing Mark with the product name “Swimming Pool Pump” or “Swimming Pool Pump or Spa Pump.”

**Double Insulation.** Pumps with a minimum 25-foot supply cord are double insulated and have inaccessible metal parts grounded with the equipment grounding conductor terminated at the attachment plug.

**GFCI.** These units are intended for connection to circuits protected by ground fault circuit interrupters and are marked, “Warning – risk of electrical shock. Connect only to a grounding type receptacle protected by a ground fault circuit interrupter (GFCI)”.

\*Note: Outlet will require a Rain-tight While in Use Cover.  
Distance from pool to receptacle shall be at least 10 ft.

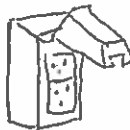

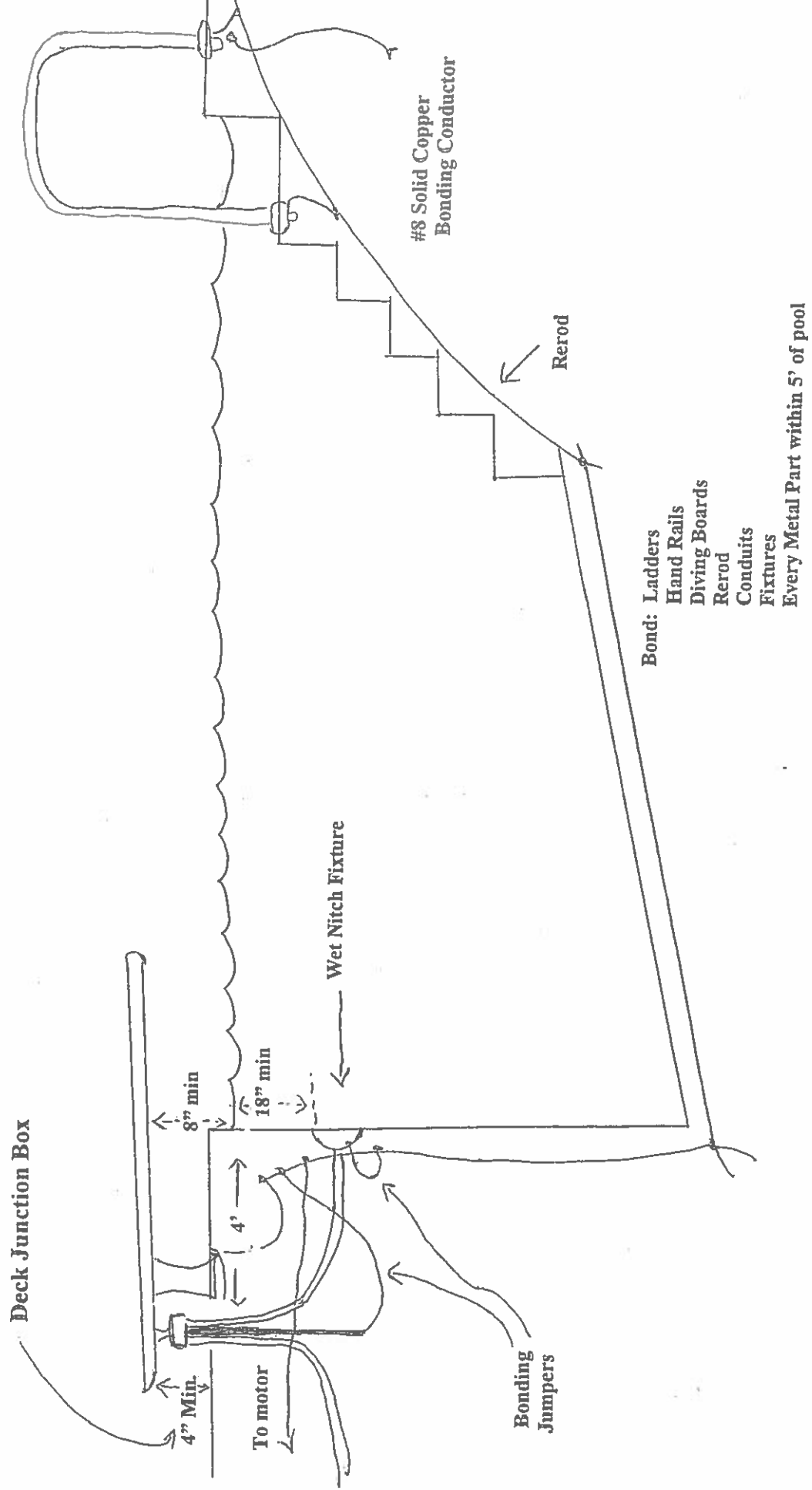

# PERMANENT SWIMMING POOL WIRING

## Nation Electrical Code

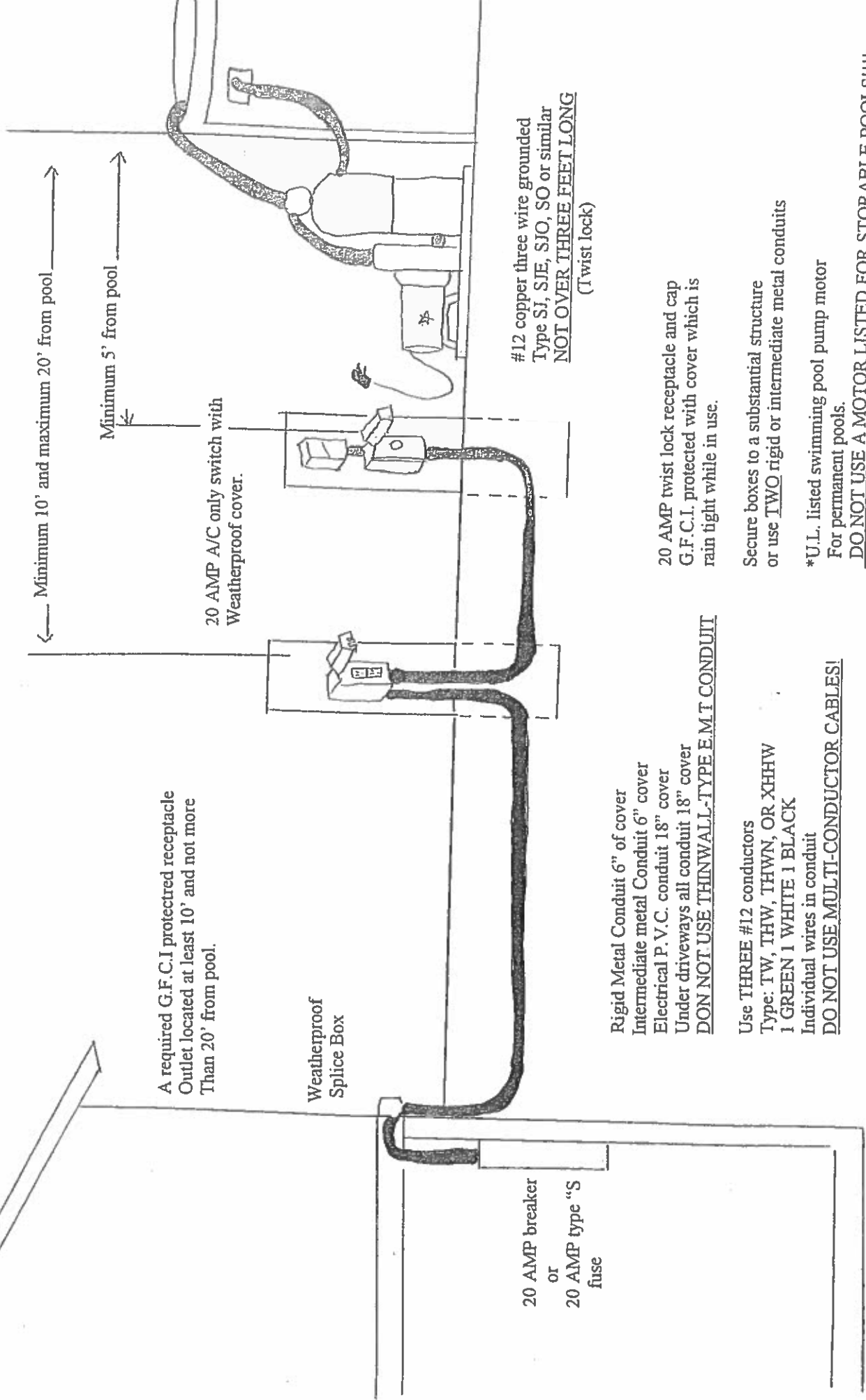

A required G.F.C.I protected receptacle Outlet located at least 10' and not more Than 20' from pool.

Weatherproof Splice Box

20 AMP A/C only switch with Weatherproof cover.

20 AMP breaker or 20 AMP type "S" fuse

← Minimum 10' and maximum 20' from pool

Minimum 5' from pool

#12 copper three wire grounded Type SJ, SJE, SJO, SO or similar NOT OVER THREE FEET LONG (Twist lock)

Rigid Metal Conduit 6" of cover  
Intermediate metal Conduit 6" cover  
Electrical P.V.C. conduit 18" cover  
Under driveways all conduit 18" cover  
DON NOT USE THINWALL-TYPE E.M.T CONDUIT

Use THREE #12 conductors  
Type: 1W, 1HW, 1HWN, OR XHHW  
1 GREEN 1 WHITE 1 BLACK  
Individual wires in conduit  
DO NOT USE MULTI-CONDUCTOR CABLES!

20 AMP twist lock receptacle and cap G.F.C.I. protected with cover which is rain tight while in use.

Secure boxes to a substantial structure or use TWO rigid or intermediate metal conduits  
\*U.L. listed swimming pool pump motor  
For permanent pools.  
DO NOT USE A MOTOR LISTED FOR STORABLE POOLS!!!!

Must also comply with bonding requirements on next page

Bond all metal parts that  
Are within five feet of the pool.

All pools which are over 42" in height  
Or cannot be readily disassembled for  
Storage and reassembled to original  
Integrity, SHALL BE BONDED

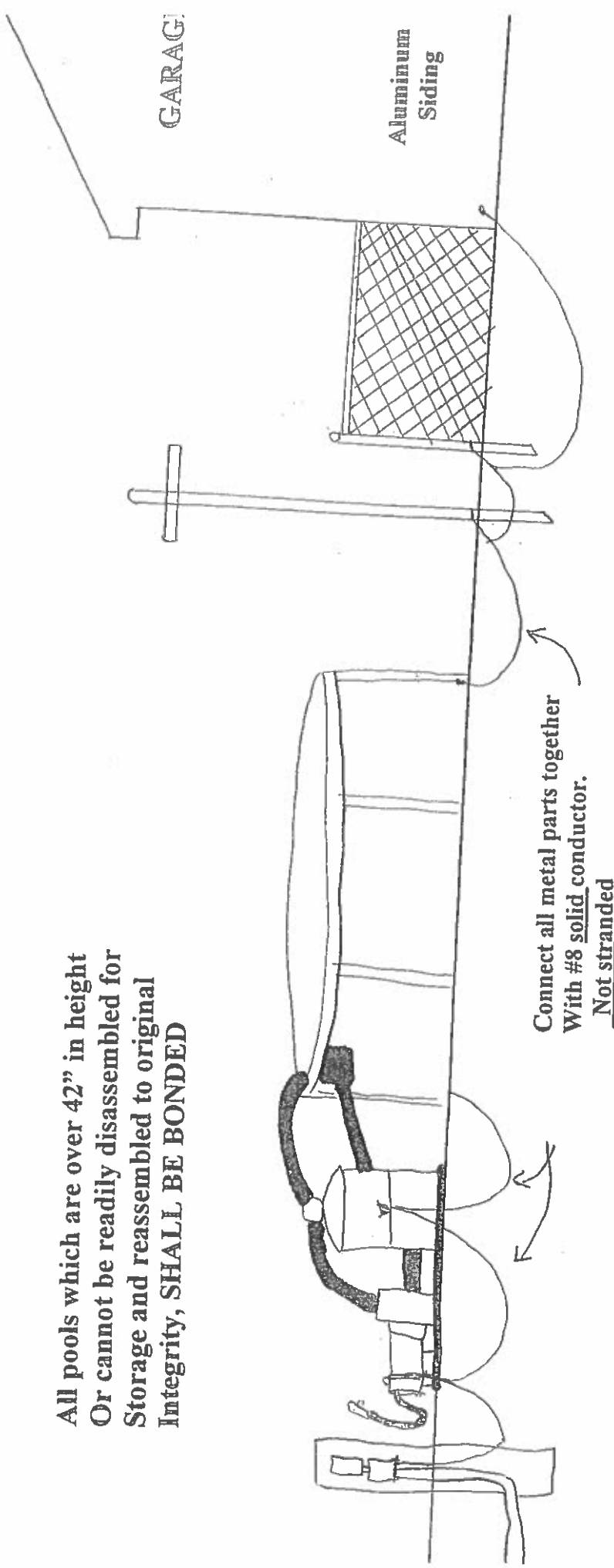

Use all copper, brass or  
Stainless steel lugs and hardware.

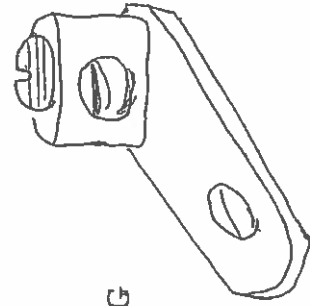

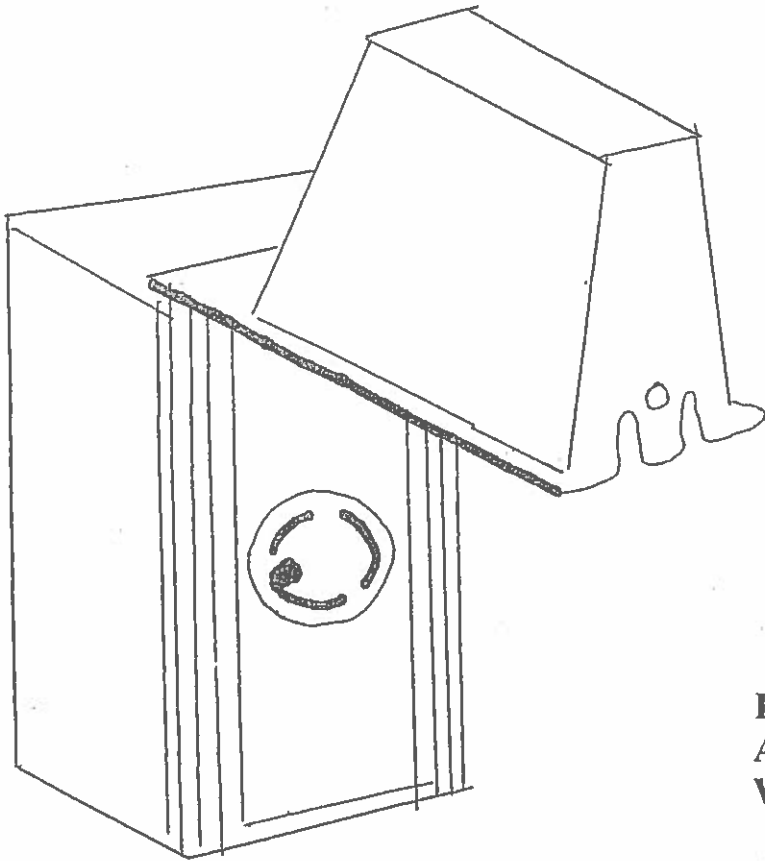

**Boxes and covers which  
Are suitable for use  
While in wet locations.**

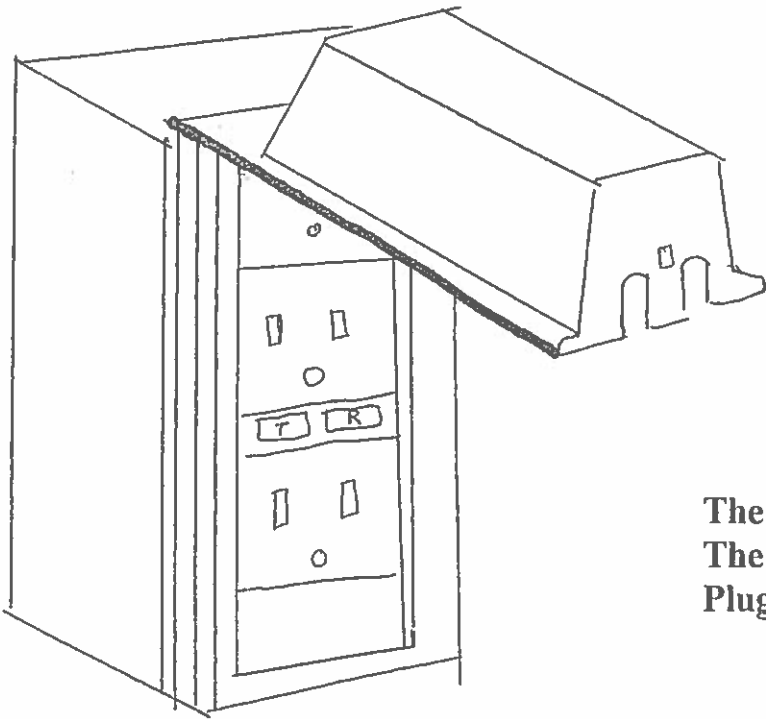

**The Cover closes after  
The attachment cap is  
Plugged in.**



TO PANEL

Where necessary for Flexibility (motors) Liquid tight flexible or Nonmetallic conduit with Approved Fittings.

Conduit Contains a grounding conductor #12 insulated copper Unspliced from panel To deck Junction box

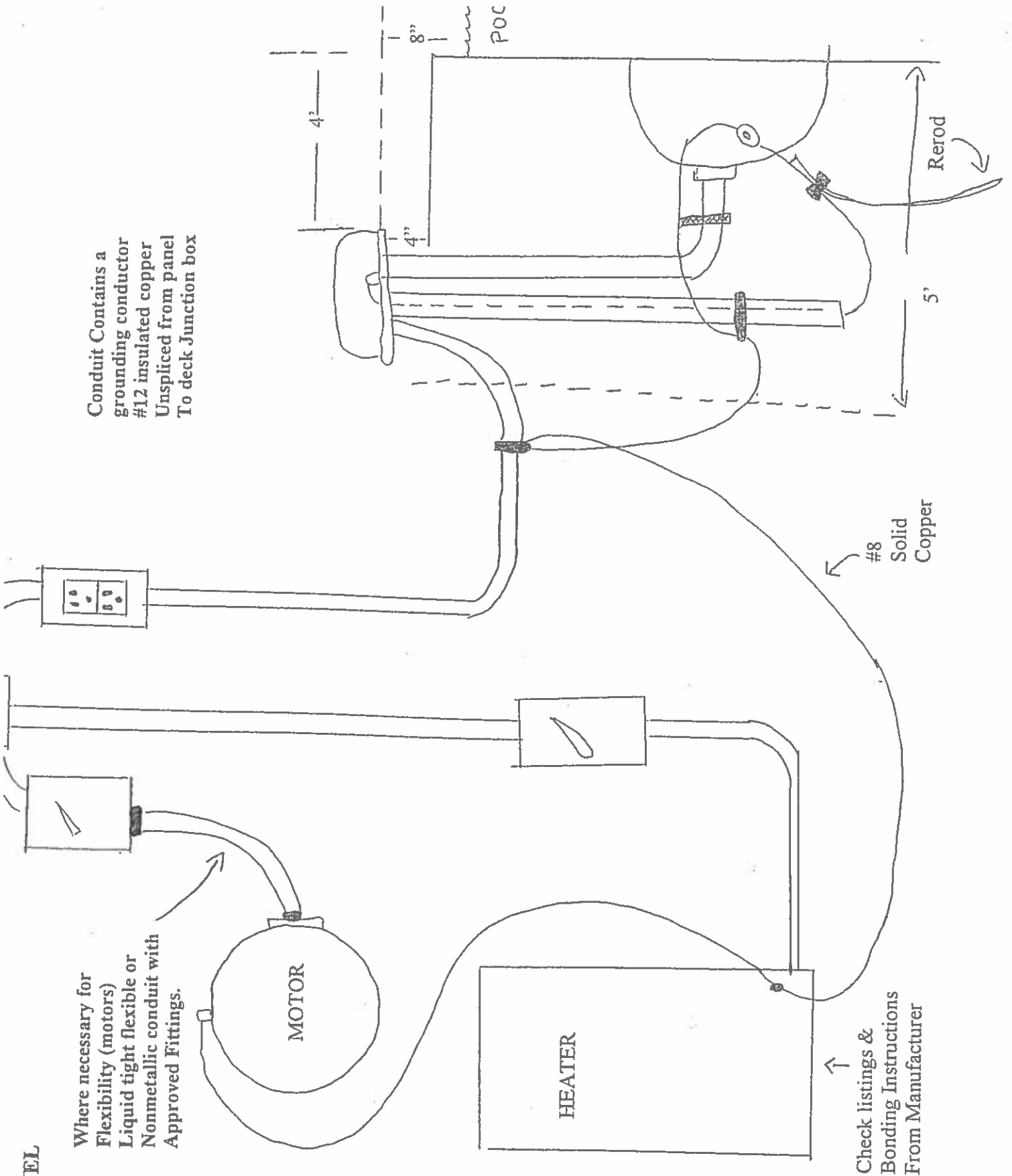

Check listings & Bonding Instructions From Manufacturer

#8 Solid Copper

Rerod

5'

POC

8"

4'

4"

## CHAPTER 42

# SWIMMING POOLS

### SECTION E4201 GENERAL

**4201.1 Scope.** The provisions of this chapter shall apply to the construction and installation of electric wiring and equipment associated with all swimming pools, wading pools, decorative pools, fountains, hot tubs and spas, and hydromassage bathtubs, whether permanently installed or storable, and shall apply to metallic auxiliary equipment, such as pumps, filters and similar equipment. Sections E4202 through E4206 provide general rules for permanent pools, spas and hot tubs. Section E4207 provides specific rules for storable pools and storable/portable spas and hot tubs. Section E4208 provides specific rules for spas and hot tubs. Section E4209 provides specific rules for hydromassage bathtubs. (680.1)

**4201.2 Definitions.** (680.2)

**CORD-AND-PLUG-CONNECTED LIGHTING ASSEMBLY.** A lighting assembly consisting of a cord-and-plug-connected transformer and a luminaire intended for installation in the wall of a spa, hot tub, or storable pool.

**DRY-NICHE LUMINAIRE.** A luminaire intended for installation in the floor or wall of a pool, spa or fountain in a niche that is sealed against the entry of water.

**FORMING SHELL.** A structure designed to support a wet-niche luminaire assembly and intended for mounting in a pool or fountain structure.

**FOUNTAIN.** Fountains, ornamental pools, display pools, and reflection pools. The definition does not include drinking fountains.

**HYDROMASSAGE BATHTUB.** A permanently installed bathtub equipped with a recirculating piping system, pump, and associated equipment. It is designed so it can accept, circulate and discharge water upon each use.

**LOW VOLTAGE CONTACT LIMIT.** A voltage not exceeding the following values:

1. 15 volts (RMS) for sinusoidal AC
2. 21.2 volts peak for nonsinusoidal AC
3. 30 volts for continuous DC
4. 12.4 volts peak for DC that is interrupted at a rate of 10 to 200 Hz

**MAXIMUM WATER LEVEL.** The highest level that water can reach before it spills out.

**NO-NICHE LUMINAIRE.** A luminaire intended for installation above or below the water without a niche.

**PACKAGED SPA OR HOT TUB EQUIPMENT ASSEMBLY.** A factory-fabricated unit consisting of water-circulating, heating and control equipment mounted on a common base, intended to operate a spa or hot tub. Equipment may include pumps, air blowers, heaters, luminaires, controls and sanitizer generators.

### PERMANENTLY INSTALLED SWIMMING, WADING, IMMERSION AND THERAPEUTIC POOLS.

Those that are constructed in the ground or partially in the ground, and all others capable of holding water with a depth greater than 42 inches (1067 mm), and all pools installed inside of a building, regardless of water depth, whether or not served by electrical circuits of any nature.

**POOL.** Manufactured or field-constructed equipment designed to contain water on a permanent or semipermanent basis and used for swimming, wading, immersion, or therapeutic purposes.

**POOL COVER, ELECTRICALLY OPERATED.** Motor-driven equipment designed to cover and uncover the water surface of a pool by means of a flexible sheet or rigid frame.

**SELF-CONTAINED SPA OR HOT TUB.** A factory-fabricated unit consisting of a spa or hot tub vessel with all water-circulating, heating and control equipment integral to the unit. Equipment may include pumps, air blowers, heaters, luminaires, controls and sanitizer generators.

**SPA OR HOT TUB.** A hydromassage pool, or tub for recreational or therapeutic use, not located in health care facilities, designed for immersion of users, and usually having a filter, heater, and motor-driven blower. They are installed indoors or outdoors, on the ground or supporting structure, or in the ground or supporting structure. Generally, a spa or hot tub is not designed or intended to have its contents drained or discharged after each use.

**STORABLE SWIMMING, WADING OR IMMERSION POOLS; OR STORABLE/PORTABLE SPAS AND HOT TUBS.** Those that are constructed on or above the ground and are capable of holding water with a maximum depth of 42 inches (1067 mm), or a pool with nonmetallic, molded polymeric walls or inflatable fabric walls regardless of dimension.

**THROUGH-WALL LIGHTING ASSEMBLY.** A lighting assembly intended for installation above grade, on or through the wall of a pool, consisting of two interconnected groups of components separated by the pool wall.

**WET-NICHE LUMINAIRE.** A luminaire intended for installation in a forming shell mounted in a pool or fountain structure where the luminaire will be completely surrounded by water.

### SECTION E4202 WIRING METHODS FOR POOLS, SPAS, HOT TUBS AND HYDROMASSAGE BATHTUBS

**E4202.1 General.** Wiring methods used in conjunction with permanently installed swimming pools, spas, hot tubs or hydromassage bathtubs shall be installed in accordance with Table E4202.1 and Chapter 38 except as otherwise stated in this section. Storable swimming pools shall comply with Section E4207. [680.7; 680.21(A); 680.23(B) and (F); 680.25(A); 680.42; 680.43; and 680.70]

**SWIMMING POOLS**

**E4202.2 Flexible cords.** Flexible cords used in conjunction with a pool, spa, hot tub or hydromassage bathtub shall be installed in accordance with the following:

1. For other than underwater luminaires, fixed or stationary equipment shall be permitted to be connected with a flexible cord to facilitate removal or disconnection for maintenance or repair. For other than storable pools, the flexible cord shall not exceed 3 feet (914 mm) in length. Cords that supply swimming pool equipment shall have a copper equipment grounding conductor not smaller than 12 AWG and shall terminate in a grounding-type attachment plug. [680.7(A), (B), and (C); 680.21(A)(5)]
2. Other than listed low-voltage lighting systems not requiring grounding, wet-niche luminaires that are supplied by a flexible cord or cable shall have all exposed noncurrent-carrying metal parts grounded by an insulated copper equipment grounding conductor that is an

integral part of the cord or cable. Such grounding conductor shall be connected to a grounding terminal in the supply junction box, transformer enclosure, or other enclosure and shall be not smaller than the supply conductors and not smaller than 16 AWG. [680.23(B)(3)]

3. A listed packaged spa or hot tub installed outdoors that is GFCI protected shall be permitted to be cord-and-plug-connected provided that such cord does not exceed 15 feet (4572 mm) in length. [680.42(A)(2)]
4. A listed packaged spa or hot tub rated at 20 amperes or less and installed indoors shall be permitted to be cord-and-plug-connected to facilitate maintenance and repair. (680.43 Exception No. 1)
5. For other than underwater and storable pool lighting luminaire, the requirements of Item 1 shall apply to any cord-equipped luminaire that is located within 16 feet (4877 mm) radially from any point on the water surface. [680.22(B)(5)]

**TABLE E4202.1**  
**ALLOWABLE APPLICATIONS FOR WIRING METHODS<sup>a, b, c, d, e, f, g, h, k</sup>**

WIRING LOCATION OR PURPOSE (Application allowed where marked with an "A")	AC, FMC, NM, SR, SE	EMT	ENT	IMC <sup>h</sup> , RMC <sup>h</sup> , RNC <sup>h</sup>	LFMC	LFNMC	UF	MC <sup>i</sup>	FLEX CORD
Panelboard(s) that supply pool equipment: from service equipment to panelboard	A <sup>b, c</sup> SR not permitted	A <sup>c</sup>	A <sup>b</sup>	A	—	A	A <sup>e</sup>	A <sup>c</sup>	—
Wet-niche and no-niche luminaires: from branch circuit OCPD to deck or junction box	AC <sup>b</sup> only	A <sup>c</sup>	A <sup>b</sup>	A	—	A	—	A <sup>b</sup>	—
Wet-niche and no-niche luminaires: from deck or junction box to forming shell	—	—	—	A <sup>d</sup>	—	A	—	—	A <sup>g</sup>
Dry niche: from branch circuit OCPD to luminaires	AC <sup>b</sup> only	A <sup>c</sup>	A <sup>b</sup>	A	—	A	—	A <sup>b</sup>	—
Pool-associated motors: from branch circuit OCPD to motor	A <sup>b</sup>	A <sup>c</sup>	A <sup>b</sup>	A	A <sup>e</sup>	A <sup>e</sup>	A <sup>b</sup>	A	A <sup>g</sup>
Packaged or self-contained outdoor spas and hot tubs with underwater luminaire: from branch circuit OCPD to spa or hot tub	AC <sup>b</sup> only	A <sup>c</sup>	A <sup>b</sup>	A	A <sup>f</sup>	A <sup>f</sup>	—	A <sup>b</sup>	A <sup>g</sup>
Packaged or self-contained outdoor spas and hot tubs without underwater luminaire: from branch circuit OCPD to spa or hot tub	A <sup>b</sup>	A <sup>c</sup>	A <sup>b</sup>	A	A <sup>f</sup>	A <sup>f</sup>	A <sup>b</sup>	A	A <sup>g</sup>
Indoor spas and hot tubs, hydromassage bathtubs, and other pool, spa or hot tub associated equipment: from branch circuit OCPD to equipment	A <sup>b</sup>	A <sup>c</sup>	A <sup>b</sup>	A	A	A	A	A	A <sup>g</sup>
Connection at pool lighting transformers or power supplies	AC <sup>b</sup> only	A <sup>c</sup>	A <sup>b</sup>	A	A <sup>h, i</sup>	A <sup>f</sup>	—	A <sup>b</sup>	—

For SI: 1 foot = 304.8 mm.

- a. For all wiring methods, see Section E4205 for equipment grounding conductor requirements.
- b. Limited to use within buildings.
- c. Limited to use on or within buildings.
- d. Metal conduit shall be constructed of brass or other approved corrosion-resistant metal.
- e. Limited to where necessary to employ flexible connections at or adjacent to a pool motor.
- f. Sections installed external to spa or hot tub enclosure limited to individual lengths not to exceed 6 feet. Length not limited inside spa or hot tub enclosure.
- g. Flexible cord shall be installed in accordance with Section E4202.2.
- h. Nonmetallic conduit shall be rigid polyvinyl chloride conduit Type PVC or reinforced thermosetting resin conduit Type RTRC.
- i. Aluminum conduits shall not be permitted in the pool area where subject to corrosion.
- j. Where installed as direct burial cable or in wet locations, Type MC cable shall be listed and identified for the location.
- k. See Section E4202.3 for listed, double-insulated pool pump motors.
- l. Limited to use in individual lengths not to exceed 6 feet. The total length of all individual runs of LFMC shall not exceed 10 feet.

**E4202.3 Double insulated pool pumps.** A listed cord and plug-connected pool pump incorporating an approved system of double insulation that provides a means for grounding only the internal and nonaccessible, noncurrent-carrying metal parts of the pump shall be connected to any wiring method recognized in Chapter 38 that is suitable for the location. Where the bonding grid is connected to the equipment grounding conductor of the motor circuit in accordance with Section E4204.2, Item 6.1, the branch circuit wiring shall comply with Sections E4202.1 and E4205.5. [680.21(B)]

### SECTION E4203 EQUIPMENT LOCATION AND CLEARANCES

**E4203.1 Receptacle outlets.** Receptacle outlets shall be installed and located in accordance with Sections E4203.1.1 through E4203.1.5. Distances shall be measured as the shortest path that an appliance supply cord connected to the receptacle would follow without penetrating a floor, wall, ceiling, doorway with hinged or sliding door, window opening, or other effective permanent barrier. [680.22(A)(5)]

**E4203.1.1 Location.** Receptacles that provide power for water-pump motors or other loads directly related to the circulation and sanitation system shall be permitted to be located between 6 feet and 10 feet (1829 mm and 3048 mm) from the inside walls of pools and outdoor spas and hot tubs, where the receptacle is single and of the grounding type and protected by ground-fault circuit interrupters.

Other receptacles on the property shall be located not less than 6 feet (1829 mm) from the inside walls of pools and outdoor spas and hot tubs. [680.22(A)(2) and (A)(3)]

**E4203.1.2 Where required.** At least one 125-volt, 15- or 20-ampere receptacle supplied by a general-purpose branch circuit shall be located a minimum of 6 feet (1829 mm) from and not more than 20 feet (6096 mm) from the inside wall of pools and outdoor spas and hot tubs. This receptacle shall be located not more than 6 feet, 6 inches (1981 mm) above the floor, platform or grade level serving the pool, spa or hot tub. [680.22(A)(1)]

**E4203.1.3 GFCI protection.** All 15- and 20-ampere, single phase, 125-volt receptacles located within 20 feet (6096 mm) of the inside walls of pools and outdoor spas and hot tubs shall be protected by a ground-fault circuit-interrupter. Outlets supplying pool pump motors supplied from branch circuits rated at 120 volts through 240 volts, single phase, whether by receptacle or direct connection, shall be provided with ground-fault circuit-interrupter protection for personnel. [680.21(C) and 680.22(A)(4)]

**E4203.1.4 Indoor locations.** Receptacles shall be located not less than 6 feet (1829 mm) from the inside walls of indoor spas and hot tubs. A minimum of one 125-volt receptacle shall be located between 6 feet (1829 mm) and 10 feet (3048 mm) from the inside walls of indoor spas or hot tubs. [680.43(A) and 680.43(A)(1)]

**E4203.1.5 Indoor GFCI protection.** All 125-volt receptacles rated 30 amperes or less and located within 10 feet

(3048 mm) of the inside walls of spas and hot tubs installed indoors, shall be protected by ground-fault circuit-interrupters. [680.43(A)(2)]

**E4203.2 Switching devices.** Switching devices shall be located not less than 5 feet (1524 mm) horizontally from the inside walls of pools, spas and hot tubs except where separated from the pool, spa or hot tub by a solid fence, wall, or other permanent barrier or the switches are listed for use within 5 feet (1524 mm). Switching devices located in a room or area containing a hydromassage bathtub shall be located in accordance with the general requirements of this code. [680.22(C); 680.43(C); and 680.72]

**E4203.3 Disconnecting means.** One or more means to simultaneously disconnect all ungrounded conductors for all utilization equipment, other than lighting, shall be provided. Each of such means shall be readily accessible and within sight from the equipment it serves and shall be located at least 5 feet (1524 mm) horizontally from the inside walls of a pool, spa, or hot tub unless separated from the open water by a permanently installed barrier that provides a 5-foot (1524 mm) or greater reach path. This horizontal distance shall be measured from the water's edge along the shortest path required to reach the disconnect. (680.12)

**E4203.4 Luminaires and ceiling fans.** Lighting outlets, luminaires, and ceiling-suspended paddle fans shall be installed and located in accordance with Sections E4203.4.1 through E4203.4.6. [680.22(B)]

**E4203.4.1 Outdoor location.** In outdoor pool, outdoor spas and outdoor hot tubs areas, luminaires, lighting outlets, and ceiling-suspended paddle fans shall not be installed over the pool or over the area extending 5 feet (1524 mm) horizontally from the inside walls of a pool except where no part of the luminaire or ceiling-suspended paddle fan is less than 12 feet (3658 mm) above the maximum water level. [680.22(B)(1)]

**E4203.4.2 Indoor locations.** In indoor pool areas, the limitations of Section E4203.4.1 shall apply except where the luminaires, lighting outlets and ceiling-suspended paddle fans comply with all of the following conditions:

1. The luminaires are of a totally enclosed type;
2. Ceiling-suspended paddle fans are identified for use beneath ceiling structures such as porches and patios.
3. A ground-fault circuit interrupter is installed in the branch circuit supplying the luminaires or ceiling-suspended paddle fans; and
4. The distance from the bottom of the luminaire or ceiling-suspended paddle fan to the maximum water level is not less than 7 feet, 6 inches (2286 mm). [680.22(B)(2)]

**E4203.4.3 Low-voltage luminaires.** Listed low-voltage luminaires not requiring grounding, not exceeding the low-voltage contact limit, and supplied by listed transformers or power supplies that comply with Section E4206.1 shall be permitted to be located less than 1.5 m (5 ft) from the inside walls of the pool. [680.22(B)(6)]

**E4203.4.4 Existing lighting outlets and luminaires.** Existing lighting outlets and luminaires that are located within 5 feet (1524 mm) horizontally from the inside walls of pools and outdoor spas and hot tubs shall be permitted to be located not less than 5 feet (1524 mm) vertically above the maximum water level, provided that such luminaires and outlets are rigidly attached to the existing structure and are protected by a ground-fault circuit-interrupter. [680.22(B)(3)]

**E4203.4.5 Indoor spas and hot tubs.**

1. Luminaires, lighting outlets, and ceiling-suspended paddle fans located over the spa or hot tub or within 5 feet (1524 mm) from the inside walls of the spa or hot tub shall be not less than 7 feet, 6 inches (2286 mm) above the maximum water level and shall be protected by a ground-fault circuit interrupter. [680.43(B)(1)(b)]

Luminaires, lighting outlets, and ceiling-suspended paddle fans that are located 12 feet (3658 mm) or more above the maximum water level shall not require ground-fault circuit interrupter protection. [680.43(B)(1)(a)]

2. Luminaires protected by a ground-fault circuit interrupter and complying with Item 2.1 or 2.2 shall be permitted to be installed less than 7 feet, 6 inches (2286 mm) over a spa or hot tub.
  - 2.1. Recessed luminaires shall have a glass or plastic lens and nonmetallic or electrically isolated metal trim, and shall be suitable for use in damp locations.
  - 2.2. Surface-mounted luminaires shall have a glass or plastic globe and a nonmetallic body or a metallic body isolated from contact. Such luminaires shall be suitable for use in damp locations. [680.43(B)(1)(c)]

**E4203.4.6 GFCI protection in adjacent areas.** Luminaires and outlets that are installed in the area extending between 5 feet (1524 mm) and 10 feet (3048 mm) from the inside walls of pools and outdoor spas and hot tubs shall be protected by ground-fault circuit-interrupters except where such fixtures and outlets are installed not less than 5 feet (1524 mm) above the maximum water level and are rigidly attached to the structure. [680.22(B)(4)]

**E4203.5 Other outlets.** Other outlets such as for remote control, signaling, fire alarm and communications shall be not less than 10 feet (3048 mm) from the inside walls of the pool. Measurements shall be determined in accordance with Section E4203.1. [680.22(D)]

**E4203.6 Overhead conductor clearances.** Except where installed with the clearances specified in Table E4203.5, the following parts of pools and outdoor spas and hot tubs shall not be placed under existing service-drop conductors, overhead service conductor, or any other open overhead wiring; nor shall such wiring be installed above the following:

1. Pools and the areas extending not less than 10 feet, (3048 mm) horizontally from the inside of the walls of the pool;
2. Diving structures and the areas extending not less than 10 feet (3048 mm) horizontally from the outer edge of such structures.
3. Observation stands, towers, and platforms and the areas extending not less than 10 feet (3048 mm) horizontally from the outer edge of such structures.

Overhead conductors of network-powered broadband communications systems shall comply with the provisions in Table E4203.5 for conductors operating at 0 to 750 volts to ground.

Utility-owned, -operated and -maintained communications conductors, community antenna system coaxial cables and the supporting messengers shall be permitted at a height of not less than 10 feet (3048 mm) above swimming and wading pools, diving structures, and observation stands, towers, and platforms. [680.8(A), (B), and (C)]

**E4203.7 Underground wiring.** Underground wiring shall not be installed under or within the area extending 5 feet (1524 mm) horizontally from the inside walls of pools and outdoor hot tubs and spas except where the wiring is installed to supply pool, spa or hot tub equipment or where space limitations prevent wiring from being routed 5 feet (1524 mm) or more horizontally from the inside walls. Where installed within 5 feet (1524 mm) of the inside walls, the wiring method shall be a complete raceway system of rigid metal conduit, intermediate metal conduit or a nonmetallic raceway system. Metal conduit shall be corrosion resistant and suitable for the location. The minimum cover depth shall be in accordance with Table E4203.7. (680.10)

**TABLE E4203.5 [Table 680.8(A)]  
OVERHEAD CONDUCTOR CLEARANCES**

	INSULATED SUPPLY OR SERVICE DROP CABLES, 0-750 VOLTS TO GROUND, SUPPORTED ON AND CABLED TOGETHER WITH AN EFFECTIVELY GROUNDED BARE MESSENGER OR EFFECTIVELY GROUNDED NEUTRAL CONDUCTOR (feet)	ALL OTHER SUPPLY OR SERVICE DROP CONDUCTORS (feet)	
		Voltage to ground	
		0-15 kV	Greater than 15 to 50 kV
A. Clearance in any direction to the water level, edge of water surface, base of diving platform, or permanently anchored raft	22.5	25	27
B. Clearance in any direction to the diving platform	14.5	17	18

For SI: 1 foot = 304.8 mm.

TABLE E4203.7 (680.10)  
MINIMUM BURIAL DEPTHS

WIRING METHOD	UNDERGROUND WIRING (Inches)
Rigid metal conduit	6
Intermediate metal conduit	6
Nonmetallic raceways listed for direct burial and under concrete exterior slab not less than 4 inches in thickness and extending not less than 6 inches (162 mm) beyond the underground installation	6
Nonmetallic raceways listed for direct burial without concrete encasement	18
Other approved raceways <sup>a</sup>	18

For SI: 1 inch = 25.4 mm.

a. Raceways approved for burial only where concrete-encased shall require a concrete envelope not less than 2 inches in thickness.

**SECTION E4204  
BONDING**

**E4204.1 Performance.** The equipotential bonding required by this section shall be installed to reduce voltage gradients in the prescribed areas of permanently installed swimming pools and spas and hot tubs other than the storable/portable type.

**E4204.2 Bonded parts.** The parts of pools, spas, and hot tubs specified in Items 1 through 7 shall be bonded together using insulated, covered or bare solid copper conductors not smaller than 8 AWG or using rigid metal conduit of brass or other identified corrosion-resistant metal. An 8 AWG or larger solid copper bonding conductor provided to reduce voltage gradients in the pool, spa, or hot tub area shall not be required to be extended or attached to remote panelboards, service equipment, or electrodes. Connections shall be made by exothermic welding, by listed pressure connectors or clamps that are labeled as being suitable for the purpose and that are made of stainless steel, brass, copper or copper alloy, machine screw-type fasteners that engage not less than two threads or are secured with a nut, thread-forming machine screws that engage not less than two-threads, or terminal bars. Connection devices or fittings that depend solely on solder shall not be used. Sheet metal screws shall not be used to connect bonding conductors or connection devices: [680.26(B)]

1. Conductive pool shells. Bonding to conductive pool shells shall be provided as specified in Item 1.1 or 1.2. Poured concrete, pneumatically applied or sprayed concrete, and concrete block with painted or plastered coatings shall be considered to be conductive materials because of their water permeability and porosity. Vinyl liners and fiberglass composite shells shall be considered to be nonconductive materials.

1.1. Structural reinforcing steel. Unencapsulated structural reinforcing steel shall be bonded together by steel tie wires or the equivalent. Where structural reinforcing steel is encapsulated in a nonconductive compound, a copper conductor grid shall be installed in accordance with Item 1.2.

1.2. Copper conductor grid. A copper conductor grid shall be provided and shall comply with Items 1.2.1 through 1.2.4:

1.2.1. It shall be constructed of minimum 8 AWG bare solid copper conductors bonded to each other at all points of crossing.

1.2.2. It shall conform to the contour of the pool.

1.2.3. It shall be arranged in a 12-inch (305 mm) by 12-inch (305 mm) network of conductors in a uniformly spaced perpendicular grid pattern with a tolerance of 4 inches (102 mm).

1.2.4. It shall be secured within or under the pool not more than 6 inches (152 mm) from the outer contour of the pool shell. [680.26(B)(1)]

2. Perimeter surfaces. The perimeter surface shall extend for 3 feet (914 mm) horizontally beyond the inside walls of the pool and shall include unpaved surfaces, poured concrete surfaces and other types of paving. Perimeter surfaces that extend less than 3 feet (914 mm) beyond the inside wall of the pool and that are separated from the pool by a permanent wall or building 5 feet (1524 mm) or more in height shall require equipotential bonding on the pool side of the permanent wall or building. Bonding to perimeter surfaces shall be provided as specified in Item 2.1 or 2.2 and shall be attached to the pool, spa, or hot tub reinforcing steel or copper conductor grid at a minimum of four points uniformly spaced around the perimeter of the pool, spa, or hot tub. For nonconductive pool shells, bonding at four points shall not be required.

**Exceptions:**

1. Equipotential bonding of perimeter surfaces shall not be required for spas and hot tubs where all of the following conditions apply:

1.1. The spa or hot tub is listed as a self-contained spa for aboveground use.

1.2. The spa or hot tub is not identified as suitable only for indoor use.

1.3. The installation is in accordance with the manufacturer's instructions and is located on or above grade.

1.4. To top rim of the spa or hot tub is not less than 28 in. (711 mm) above all perimeter surfaces that are within 30 in. (762 mm), measured horizontally from the spa or hot tub. The height of nonconductive external steps for entry

to or exit from the self-contained spa is not used to reduce or increase this rim height measurement.

2. The equipotential bonding requirements for perimeter surfaces shall not apply to a listed self-contained spa or hot tub located indoors and installed above a finished floor.
  - 2.1. Structural reinforcing steel. Structural reinforcing steel shall be bonded in accordance with Item 1.1.
  - 2.2. Alternate means. Where structural reinforcing steel is not available or is encapsulated in a nonconductive compound, a copper conductor(s) shall be used in accordance with Items 2.2.1 through 2.2.5:
    - 2.2.1. At least one minimum 8 AWG bare solid copper conductor shall be provided.
    - 2.2.2. The conductors shall follow the contour of the perimeter surface.
    - 2.2.3. Splices shall be listed.
    - 2.2.4. The required conductor shall be 18 to 24 inches (457 to 610 mm) from the inside walls of the pool.
    - 2.2.5. The required conductor shall be secured within or under the perimeter surface 4 to 6 inches (102 mm to 152 mm) below the subgrade. [680.26(B)(2)]
3. Metallic components. All metallic parts of the pool structure, including reinforcing metal not addressed in Item 1.1, shall be bonded. Where reinforcing steel is encapsulated with a nonconductive compound, the reinforcing steel shall not be required to be bonded. [680.26(B)(3)]
4. Underwater lighting. All metal forming shells and mounting brackets of no-niche luminaires shall be bonded. [680.26(B)(4)]
 

**Exception:** Listed low-voltage lighting systems with nonmetallic forming shells shall not require bonding. [680.26(B)(4) Exception]
5. Metal fittings. All metal fittings within or attached to the pool structure shall be bonded. Isolated parts that are not over 4 inches (102 mm) in any dimension and do not penetrate into the pool structure more than 1 inch (25.4 mm) shall not require bonding. [680.26(B)(5)]
6. Electrical equipment. Metal parts of electrical equipment associated with the pool water circulating system, including pump motors and metal parts of equipment associated with pool covers, including electric motors, shall be bonded. [680.26(B)(6)]

**Exception:** Metal parts of listed equipment incorporating an approved system of double insulation shall not be bonded. [680.26(B)(6) Exception]

- 6.1. Double-insulated water pump motors. Where a double-insulated water pump motor is installed under the provisions of this item, a solid 8 AWG copper conductor of sufficient length to make a bonding connection to a replacement

motor shall be extended from the bonding grid to an accessible point in the vicinity of the pool pump motor. Where there is no connection between the swimming pool bonding grid and the equipment grounding system for the premises, this bonding conductor shall be connected to the equipment grounding conductor of the motor circuit. [680.26(B)(6)(a)]

- 6.2. Pool water heaters. For pool water heaters rated at more than 50 amperes and having specific instructions regarding bonding and grounding, only those parts designated to be bonded shall be bonded and only those parts designated to be grounded shall be grounded. [680.26(B)(6)(b)]
7. All fixed metal parts including, but not limited to, metal-sheathed cables and raceways, metal piping, metal awnings, metal fences and metal door and window frames. [680.26(B)(7)]

**Exceptions:**

1. Those separated from the pool by a permanent barrier that prevents contact by a person shall not be required to be bonded. [680.26(B)(7) Exception No. 1]
2. Those greater than 5 feet (1524 mm) horizontally from the inside walls of the pool shall not be required to be bonded. [680.26(B)(7) Exception No. 2]
3. Those greater than 12 feet (3658 mm) measured vertically above the maximum water level of the pool, or as measured vertically above any observation stands, towers, or platforms, or any diving structures, shall not be required to be bonded. [680.26(B)(7) Exception No. 3]

**E4204.3 Pool water.** Where none of the bonded parts is in direct connection with the pool water, the pool water shall be in direct contact with an approved corrosion-resistant conductive surface that exposes not less than 9 in.<sup>2</sup> (5800 mm<sup>2</sup>) of surface area to the pool water at all times. The conductive surface shall be located where it is not exposed to physical damage or dislodgement during usual pool activities, and it shall be bonded in accordance with Section E4204.2.

**E4204.4 Bonding of outdoor hot tubs and spas.** Outdoor hot tubs and spas shall comply with the bonding requirements of Sections E4204.1 through E4204.3. Bonding by metal-to-metal mounting on a common frame or base shall be permitted. The metal bands or hoops used to secure wooden staves shall not be required to be bonded as required in Section E4204.2. [680.42 and 680.42(B)]

**E4204.5 Bonding of indoor hot tubs and spas.** The following parts of indoor hot tubs and spas shall be bonded together:

1. All metal fittings within or attached to the hot tub or spa structure. [680.43(D)(1)]
2. Metal parts of electrical equipment associated with the hot tub or spa water circulating system, including pump

motors unless part of a listed self-contained spa or hot tub. [680.43(D)(2)]

3. Metal raceway and metal piping that are within 5 feet (1524 mm) of the inside walls of the hot tub or spa and that are not separated from the spa or hot tub by a permanent barrier. [680.43(D)(3)]
4. All metal surfaces that are within 5 feet (1524 mm) of the inside walls of the hot tub or spa and that are not separated from the hot tub or spa area by a permanent barrier. [680.43(D)(4)]

**Exception:** Small conductive surfaces not likely to become energized, such as air and water jets and drain fittings, where not connected to metallic piping, towel bars, mirror frames, and similar nonelectrical equipment, shall not be required to be bonded. [680.43(D)(4) Exception]

5. Electrical devices and controls that are not associated with the hot tubs or spas and that are located less than 5 feet (1524 mm) from such units. [680.43(D)(5)]

**E4204.5.1 Methods.** All metal parts associated with the hot tub or spa shall be bonded by any of the following methods:

1. The interconnection of threaded metal piping and fittings. [680.43(E)(1)]
2. Metal-to-metal mounting on a common frame or base. [680.43(E)(2)]
3. The provision of an insulated, covered or bare solid copper bonding jumper not smaller than 8 AWG. It shall not be the intent to require that the 8 AWG or larger solid copper bonding conductor be extended or attached to any remote panelboard, service equipment, or any electrode, but only that it shall be employed to eliminate voltage gradients in the hot tub or spa area as prescribed. [680.43(E)(3)]

**E4204.5.2 Connections.** Connections to bonded parts shall be made in accordance with Section E3406.13.1.

## SECTION E4205 GROUNDING

**E4205.1 Equipment to be grounded.** The following equipment shall be grounded:

1. Through-wall lighting assemblies and underwater luminaires other than those low-voltage lighting products listed for the application without a grounding conductor.
2. All electrical equipment located within 5 feet (1524 mm) of the inside wall of the pool, spa or hot tub.
3. All electrical equipment associated with the recirculating system of the pool, spa or hot tub.
4. Junction boxes.
5. Transformer and power supply enclosures.
6. Ground-fault circuit-interrupters.

7. Panelboards that are not part of the service equipment and that supply any electrical equipment associated with the pool, spa or hot tub. (680.7)

**E4205.2 Luminaires and related equipment.** Other than listed low-voltage luminaires not requiring grounding, all through-wall lighting assemblies, wet-niche, dry-niche, or no-niche luminaires shall be connected to an insulated copper equipment grounding conductor sized in accordance with Table E3908.12 but not smaller than 12 AWG. The equipment grounding conductor between the wiring chamber of the secondary winding of a transformer and a junction box shall be sized in accordance with the overcurrent device in such circuit. The junction box, transformer enclosure, or other enclosure in the supply circuit to a wet-niche or no-niche luminaire and the field-wiring chamber of a dry-niche luminaire shall be grounded to the equipment grounding terminal of the panelboard. The equipment grounding terminal shall be directly connected to the panelboard enclosure. The equipment grounding conductor shall be installed without joint or splice. [680.23(F)(2) and 680.23(F)(2) Exception]

### Exceptions:

1. Where more than one underwater luminaire is supplied by the same branch circuit, the equipment grounding conductor, installed between the junction boxes, transformer enclosures, or other enclosures in the supply circuit to wet-niche luminaires, or between the field-wiring compartments of dry-niche luminaires, shall be permitted to be terminated on grounding terminals. [680.23(F)(2)(a)]
2. Where an underwater luminaire is supplied from a transformer, ground-fault circuit-interrupter, clock-operated switch, or a manual snap switch that is located between the panelboard and a junction box connected to the conduit that extends directly to the underwater luminaire, the equipment grounding conductor shall be permitted to terminate on grounding terminals on the transformer, ground-fault circuit-interrupter, clock-operated switch enclosure, or an outlet box used to enclose a snap switch. [680.23(F)(2)(b)]

**E4205.3 Nonmetallic conduit.** Where a nonmetallic conduit is installed between a forming shell and a junction box, transformer enclosure, or other enclosure, a 8 AWG insulated copper bonding jumper shall be installed in this conduit except where a listed low-voltage lighting system not requiring grounding is used. The bonding jumper shall be terminated in the forming shell, junction box or transformer enclosure, or ground-fault circuit-interrupter enclosure. The termination of the 8 AWG bonding jumper in the forming shell shall be covered with, or encapsulated in, a listed potting compound to protect such connection from the possible deteriorating effect of pool water. [680.23(B)(2)(b)]

**E4205.4 Flexible cords.** Other than listed low-voltage lighting systems not requiring grounding, wet-niche luminaires that are supplied by a flexible cord or cable shall have all exposed noncurrent-carrying metal parts grounded by an insulated copper equipment grounding conductor that is an integral part of the cord or cable. This grounding conductor



shall be connected to a grounding terminal in the supply junction box, transformer enclosure, or other enclosure. The grounding conductor shall not be smaller than the supply conductors and not smaller than 16 AWG. [680.23(B)(3)]

**E4205.5 Motors.** Pool-associated motors shall be connected to an insulated copper equipment grounding conductor sized in accordance with Table E3908.12, but not smaller than 12 AWG. Where the branch circuit supplying the motor is installed in the interior of a one-family dwelling or in the interior of accessory buildings associated with a one-family dwelling, using a cable wiring method permitted by Table E4202.1, an uninsulated equipment grounding conductor shall be permitted provided that it is enclosed within the outer sheath of the cable assembly. [680.21(A)(1) and (A)(4)]

**E4205.6 Feeders.** An equipment grounding conductor shall be installed with the feeder conductors between the grounding terminal of the pool equipment panelboard and the grounding terminal of the applicable service equipment. The equipment grounding conductor shall be insulated, shall be sized in accordance with Table E3908.12, and shall be not smaller than 12 AWG.

**E4205.6.1 Separate buildings.** A feeder to a separate building or structure shall be permitted to supply swimming pool equipment branch circuits, or feeders supplying swimming pool equipment branch circuits, provided that the grounding arrangements in the separate building meet the requirements of Section E3607.3. The feeder equipment grounding conductor shall be an insulated conductor. (680.25(B)(2))

**E4205.7 Cord-connected equipment.** Where fixed or stationary equipment is connected with a flexible cord to facilitate removal or disconnection for maintenance, repair, or storage, as provided in Section E4202.2, the equipment grounding conductors shall be connected to a fixed metal part of the assembly. The removable part shall be mounted on or bonded to the fixed metal part. [680.7(C)]

**E4205.8 Other equipment.** Other electrical equipment shall be grounded in accordance with Section E3908. (Article 250, Parts V, VI, and VII; and 680.6)

## SECTION E4206 EQUIPMENT INSTALLATION

**E4206.1 Transformers and power supplies.** Transformers and power supplies used for the supply of underwater luminaires, together with the transformer or power supply enclosure, shall be listed for swimming pool and spa use. The transformer or power supply shall incorporate either a transformer of the isolated-winding type with an ungrounded secondary that has a grounded metal barrier between the primary and secondary windings, or a transformer that incorporates an approved system of double insulation between the primary and secondary windings. [680.23(A)(2)]

**E4206.2 Ground-fault circuit-interrupters.** Ground-fault circuit-interrupters shall be self-contained units, circuit-breaker types, receptacle types or other approved types. (680.5)

**E4206.3 Wiring on load side of ground-fault circuit-interrupters and transformers.** For other than grounding con-

ductors, conductors installed on the load side of a ground-fault circuit-interrupter or transformer used to comply with the provisions of Section E4206.4, shall not occupy raceways, boxes, or enclosures containing other conductors except where the other conductors are protected by ground-fault circuit interrupters or are grounding conductors. Supply conductors to a feed-through type ground-fault circuit interrupter shall be permitted in the same enclosure. Ground-fault circuit interrupters shall be permitted in a panelboard that contains circuits protected by other than ground-fault circuit interrupters. [680.23(F)(3)]

**E4206.4 Underwater luminaires.** The design of an underwater luminaire supplied from a branch circuit either directly or by way of a transformer or power supply meeting the requirements of Section E4206.1, shall be such that, where the fixture is properly installed without a ground-fault circuit-interrupter, there is no shock hazard with any likely combination of fault conditions during normal use (not relamping). In addition, a ground-fault circuit-interrupter shall be installed in the branch circuit supplying luminaires operating at more than the low-voltage contact limit, such that there is no shock hazard during relamping. The installation of the ground-fault circuit-interrupter shall be such that there is no shock hazard with any likely fault-condition combination that involves a person in a conductive path from any ungrounded part of the branch circuit or the luminaire to ground. Compliance with this requirement shall be obtained by the use of a listed underwater luminaire and by installation of a listed ground-fault circuit-interrupter in the branch circuit or a listed transformer or power supply for luminaires operating at more than the low-voltage contact limit. Luminaires that depend on submersion for safe operation shall be inherently protected against the hazards of overheating when not submerged. [680.23(A)(1), (A)(3), (A)(7) and (A)(8)]

**E4206.4.1 Maximum voltage.** Luminaires shall not be installed for operation on supply circuits over 150 volts between conductors. [680.23(A)(4)]

**E4206.4.2 Luminaire location.** Luminaires mounted in walls shall be installed with the top of the fixture lens not less than 18 inches (457 mm) below the normal water level of the pool, except where the luminaire is listed and identified for use at a depth of not less than 4 inches (102 mm) below the normal water level of the pool. A luminaire facing upward shall have the lens adequately guarded to prevent contact by any person or shall be listed for use without a guard. [680.23(A)(5) and (A)(6)]

**E4206.5 Wet-niche luminaires.** Forming shells shall be installed for the mounting of all wet-niche underwater luminaires and shall be equipped with provisions for conduit entries. Conduit shall extend from the forming shell to a suitable junction box or other enclosure located as provided in Section E4206.9. Metal parts of the luminaire and forming shell in contact with the pool water shall be of brass or other approved corrosion-resistant metal. [680.23(B)(1)]

The end of flexible-cord jackets and flexible-cord conductor terminations within a luminaire shall be covered with, or encapsulated in, a suitable potting compound to prevent the entry of water into the luminaire through the cord or its con-

ductors. If present, the grounding connection within a luminaire shall be similarly treated to protect such connection from the deteriorating effect of pool water in the event of water entry into the luminaire. [680.23(B)(4)]

Luminaires shall be bonded to and secured to the forming shell by a positive locking device that ensures a low-resistance contact and requires a tool to remove the luminaire from the forming shell. [680.23(B)(5)]

**E4206.5.1 Servicing.** All wet-niche luminaires shall be removable from the water for inspection, relamping, or other maintenance. The forming shell location and length of cord in the forming shell shall permit personnel to place the removed luminaire on the deck or other dry location for such maintenance. The luminaire maintenance location shall be accessible without entering or going into the pool water. [680.23(B)(6)]

**E4206.6 Dry-niche luminaires.** Dry-niche luminaires shall have provisions for drainage of water. Other than listed low-voltage luminaires not requiring grounding, a dry-niche luminaire shall have means for accommodating one equipment grounding conductor for each conduit entry. Junction boxes shall not be required but, if used, shall not be required to be elevated or located as specified in Section E4206.9 if the luminaire is specifically identified for the purpose. [680.23(C)(1) and (C)(2)]

**E4206.7 No-niche luminaires.** No-niche luminaires shall be listed for the purpose and shall be installed in accordance with the requirements of Section E4206.5. Where connection to a forming shell is specified, the connection shall be to the mounting bracket. [680.23(D)]

**E4206.8 Through-wall lighting assembly.** A through-wall lighting assembly shall be equipped with a threaded entry or hub, or a nonmetallic hub, for the purpose of accommodating the termination of the supply conduit. A through-wall lighting assembly shall meet the construction requirements of Section E4205.4 and be installed in accordance with the requirements of Section E4206.5. Where connection to a forming shell is specified, the connection shall be to the conduit termination point. [680.23(E)]

**E4206.9 Junction boxes and enclosures for transformers or ground-fault circuit interrupters.** Junction boxes for underwater luminaires and enclosures for transformers and ground-fault circuit-interrupters that supply underwater luminaires shall comply with the following: [680.24(A)]

**E4206.9.1 Junction boxes.** A junction box connected to a conduit that extends directly to a forming shell or mounting bracket of a no-niche luminaire shall be:

1. Listed as a swimming pool junction box; [680.24(A)(1)]
2. Equipped with threaded entries or hubs or a nonmetallic hub; [680.24(A)(1)(1)]
3. Constructed of copper, brass, suitable plastic, or other approved corrosion-resistant material; [680.24(A)(1)(2)]
4. Provided with electrical continuity between every connected metal conduit and the grounding terminal

by means of copper, brass, or other approved corrosion-resistant metal that is integral with the box; and [680.24(A)(1)(3)]

5. Located not less than 4 inches (102 mm), measured from the inside of the bottom of the box, above the ground level, or pool deck, or not less than 8 inches (203 mm) above the maximum pool water level, whichever provides the greatest elevation, and shall be located not less than 4 feet (1219 mm) from the inside wall of the pool, unless separated from the pool by a solid fence, wall or other permanent barrier. Where used on a lighting system operating at the low-voltage contact limit or less, a flush deck box shall be permitted provided that an approved potting compound is used to fill the box to prevent the entrance of moisture; and the flush deck box is located not less than 4 feet (1219 mm) from the inside wall of the pool. [680.24(A)(2)]

**E4206.9.2 Other enclosures.** An enclosure for a transformer, ground-fault circuit-interrupter or a similar device connected to a conduit that extends directly to a forming shell or mounting bracket of a no-niche luminaire shall be:

1. Listed and labeled for the purpose, comprised of copper, brass, suitable plastic, or other approved corrosion-resistant material; [680.24(B)(1)]
2. Equipped with threaded entries or hubs or a nonmetallic hub; [680.24(B)(2)]
3. Provided with an approved seal, such as duct seal at the conduit connection, that prevents circulation of air between the conduit and the enclosures; [680.24(B)(3)]
4. Provided with electrical continuity between every connected metal conduit and the grounding terminals by means of copper, brass or other approved corrosion-resistant metal that is integral with the enclosures; and [680.24(B)(4)]
5. Located not less than 4 inches (102 mm), measured from the inside bottom of the enclosure, above the ground level or pool deck, or not less than 8 inches (203 mm) above the maximum pool water level, whichever provides the greater elevation, and shall be located not less than 4 feet (1219 mm) from the inside wall of the pool, except where separated from the pool by a solid fence, wall or other permanent barrier. [680.24(B)(2)]

**E4206.9.3 Protection of junction boxes and enclosures.** Junction boxes and enclosures mounted above the grade of the finished walkway around the pool shall not be located in the walkway unless afforded additional protection, such as by location under diving boards or adjacent to fixed structures. [680.24(C)]

**E4206.9.4 Grounding terminals.** Junction boxes, transformer and power supply enclosures, and ground-fault circuit-interrupter enclosures connected to a conduit that extends directly to a forming shell or mounting bracket of a no-niche luminaire shall be provided with grounding terminal

minals in a quantity not less than the number of conduit entries plus one. [680.24(D)]

**E4206.9.5 Strain relief.** The termination of a flexible cord of an underwater luminaire within a junction box, transformer or power supply enclosure, ground-fault circuit-interrupter, or other enclosure shall be provided with a strain relief. [680.24(E)]

**E4206.10 Underwater audio equipment.** Underwater audio equipment shall be identified for the purpose. [680.27(A)]

**E4206.10.1 Speakers.** Each speaker shall be mounted in an approved metal forming shell, the front of which is enclosed by a captive metal screen, or equivalent, that is bonded to and secured to the forming shell by a positive locking device that ensures a low-resistance contact and requires a tool to open for installation or servicing of the speaker. The forming shell shall be installed in a recess in the wall or floor of the pool. [680.27(A)(1)]

**E4206.10.2 Wiring methods.** Rigid metal conduit of brass or other identified corrosion-resistant metal, rigid polyvinyl chloride conduit, rigid thermosetting resin conduit or liquid-tight flexible nonmetallic conduit (LFNC-B) shall extend from the forming shell to a suitable junction box or other enclosure as provided in Section E4206.9. Where rigid nonmetallic conduit or liquid-tight flexible nonmetallic conduit is used, an 8 AWG solid or stranded insulated copper bonding jumper shall be installed in this conduit with provisions for terminating in the forming shell and the junction box. The termination of the 8 AWG bonding jumper in the forming shell shall be covered with, or encapsulated in, a suitable potting compound to protect such connection from the possible deteriorating effect of pool water. [680.27(A)(2)]

**E4206.10.3 Forming shell and metal screen.** The forming shell and metal screen shall be of brass or other approved corrosion-resistant metal. Forming shells shall include provisions for terminating an 8 AWG copper conductor. [680.27(A)(3)]

**E4206.11 Electrically operated pool covers.** The electric motors, controllers, and wiring for pool covers shall be located not less than 5 feet (1524 mm) from the inside wall of the pool except where separated from the pool by a wall, cover, or other permanent barrier. Electric motors installed below grade level shall be of the totally enclosed type. The electric motor and controller shall be connected to a branch circuit protected by a ground-fault circuit-interrupter. The device that controls the operation of the motor for an electrically operated pool cover shall be located so that the operator has full view of the pool. [680.27(B)(1) and (B)(2)]

**E4206.12 Electric pool water heaters.** Electric pool water heaters shall have the heating elements subdivided into loads not exceeding 48 amperes and protected at not more than 60 amperes. The ampacity of the branch-circuit conductors and the rating or setting of overcurrent protective devices shall be not less than 125 percent of the total nameplate load rating. (680.9)

**E4206.13 Pool area heating.** The provisions of Sections E4206.13.1 through E4206.13.3 shall apply to all pool deck

areas, including a covered pool, where electrically operated comfort heating units are installed within 20 feet (6096 mm) of the inside wall of the pool. [680.27(C)]

**E4206.13.1 Unit heaters.** Unit heaters shall be rigidly mounted to the structure and shall be of the totally enclosed or guarded types. Unit heaters shall not be mounted over the pool or within the area extending 5 feet (1524 mm) horizontally from the inside walls of a pool. [680.27(C)(1)]

**E4206.13.2 Permanently wired radiant heaters.** Electric radiant heaters shall be suitably guarded and securely fastened to their mounting devices. Heaters shall not be installed over a pool or within the area extending 5 feet (1524 mm) horizontally from the inside walls of the pool and shall be mounted not less than 12 feet (3658 mm) vertically above the pool deck. [680.27(C)(2)]

**E4206.13.3 Radiant heating cables prohibited.** Radiant heating cables embedded in or below the deck shall be prohibited. [680.27(C)(3)]

## SECTION E4207 STORABLE SWIMMING POOLS, STORABLE SPAS, AND STORABLE HOT TUBS

**E4207.1 Pumps.** A cord and plug-connected pool filter pump for use with storable pools shall incorporate an approved system of double insulation or its equivalent and shall be provided with means for grounding only the internal and nonaccessible noncurrent-carrying metal parts of the appliance.

The means for grounding shall be an equipment grounding conductor run with the power-supply conductors in a flexible cord that is properly terminated in a grounding-type attachment plug having a fixed grounding contact. Cord and plug-connected pool filter pumps shall be provided with a ground-fault circuit interrupter that is an integral part of the attachment plug or located in the power supply cord within 12 inches (305 mm) of the attachment plug. (680.31)

**E4207.2 Ground-fault circuit-interrupters required.** Electrical equipment, including power-supply cords, used with storable pools shall be protected by ground-fault circuit-interrupters. 125-volt, 15- and 20-ampere receptacles located within 20 feet (6096 mm) of the inside walls of a storable pool, storable spa, or storable hot tub shall be protected by a ground-fault circuit interrupter. In determining these dimensions, the distance to be measured shall be the shortest path that the supply cord of an appliance connected to the receptacle would follow without passing through a floor, wall, ceiling, doorway with hinged or sliding door, window opening, or other effective permanent barrier. (680.32)

**E4207.3 Luminaires.** Luminaires for storable pools, storable spas, and storable hot tubs shall not have exposed metal parts and shall be listed for the purpose as an assembly. In addition, luminaires for storable pools shall comply with the requirements of Section E4207.3.1 or E4207.3.2. (680.33)

**E4207.3.1 Within the low-voltage contact limit.** A luminaire installed in or on the wall of a storable pool shall be

part of a cord and plug-connected lighting assembly. The assembly shall:

1. Have a luminaire lamp that is suitable for the use at the supplied voltage;
2. Have an impact-resistant polymeric lens, luminaire body, and transformer enclosure;
3. Have a transformer meeting the requirements of section E4206.1 with a primary rating not over 150 volts; and
4. Have no exposed metal parts. [680.33(A)]

**E4207.3.2 Over the low-voltage contact limit but not over 150 volts.** A lighting assembly without a transformer or power supply, and with the luminaire lamp(s) operating at over the low-voltage contact limit, but not over 150 volts, shall be permitted to be cord and plug-connected where the assembly is listed as an assembly for the purpose and complies with all of the following:

1. It has an impact-resistant polymeric lens and luminaire body.
2. A ground-fault circuit interrupter with open neutral conductor protection is provided as an integral part of the assembly.
3. The luminaire lamp is permanently connected to the ground-fault circuit interrupter with open-neutral protection.
4. It complies with the requirements of Section E4206.4.
5. It has no exposed metal parts. [680.33(B)]

**E4207.4 Receptacle locations.** Receptacles shall be located not less than 6 feet (1829 mm) from the inside walls of a storable pool, storable spa or storable hot tub. In determining these dimensions, the distance to be measured shall be the shortest path that the supply cord of an appliance connected to the receptacle would follow without passing through a floor, wall, ceiling, doorway with hinged or sliding door, window opening, or other effective permanent barrier. (680.34)

**E4207.5 Clearances.** Overhead conductor installations shall comply with Section E4203.6 and underground conductor installations shall comply with Section E4203.7.

**E4207.6 Disconnecting means.** Disconnecting means for storable pools and storable/portable spas and hot tubs shall comply with Section E4203.3.

**E4207.7 Ground-fault circuit interrupters.** Ground-fault circuit interrupters shall comply with Section E4206.2.

**E4207.8 Grounding of equipment.** Equipment shall be grounded as required by Section E4205.1.

**E4207.9 Pool water heaters.** Electric pool water heaters shall comply with Section E4206.12.

## SECTION E4208 SPAS AND HOT TUBS

**E4208.1 Ground-fault circuit-interrupters.** The outlet(s) that supplies a self-contained spa or hot tub, or a packaged

spa or hot tub equipment assembly, or a field-assembled spa or hot tub with a heater load of 50 amperes or less, shall be protected by a ground-fault circuit-interrupter. (680.44)

A listed self-contained unit or listed packaged equipment assembly marked to indicate that integral ground-fault circuit-interrupter protection is provided for all electrical parts within the unit or assembly, including pumps, air blowers, heaters, lights, controls, sanitizer generators and wiring, shall not require that the outlet supply be protected by a ground-fault circuit interrupter. [680.44(A)]

**E4208.2 Electric water heaters.** Electric spa and hot tub water heaters shall be listed and shall have the heating elements subdivided into loads not exceeding 48 amperes and protected at not more than 60 amperes. The ampacity of the branch-circuit conductors, and the rating or setting of over-current protective devices, shall be not less than 125 percent of the total nameplate load rating. (680.9)

**E4208.3 Underwater audio equipment.** Underwater audio equipment used with spas and hot tubs shall comply with the provisions of Section E4206.10. [680.43(G)]

**E4208.4 Emergency switch for spas and hot tubs.** A clearly labeled emergency shutoff or control switch for the purpose of stopping the motor(s) that provides power to the recirculation system and jet system shall be installed at a point that is readily accessible to the users, adjacent to and within sight of the spa or hot tub and not less than 5 feet (1524 mm) away from the spa or hot tub. This requirement shall not apply to single-family dwellings. (680.41)

## SECTION E4209 HYDROMASSAGE BATHTUBS

**E4209.1 Ground-fault circuit-interrupters.** Hydromassage bathtubs and their associated electrical components shall be supplied by an individual branch circuit(s) and protected by a readily accessible ground-fault circuit-interrupter. All 125-volt, single-phase receptacles not exceeding 30 amperes and located within 6 feet (1829 mm) measured horizontally of the inside walls of a hydromassage tub shall be protected by a ground-fault circuit interrupter(s). (680.71)

**E4209.2 Other electric equipment.** Luminaires, switches, receptacles, and other electrical equipment located in the same room, and not directly associated with a hydromassage bathtub, shall be installed in accordance with the requirements of this code relative to the installation of electrical equipment in bathrooms. (680.72)

**E4209.3 Accessibility.** Hydromassage bathtub electrical equipment shall be accessible without damaging the building structure or building finish. Where the hydromassage bathtub is cord- and plug-connected with the supply receptacle accessible only through a service access opening, the receptacle shall be installed so that its face is within direct view and not more than 12 inches (305 mm) from the plane of the opening. (680.73)

**E4209.4 Bonding.** Both metal piping systems and grounded metal parts in contact with the circulating water shall be bonded together using an insulated, covered or bare solid copper bonding jumper not smaller than 8 AWG. The bond-

## SWIMMING POOLS

ing jumper shall be connected to the terminal on the circulating pump motor that is intended for this purpose. The bonding jumper shall not be required to be connected to a double insulated circulating pump motor. The 8 AWG or larger solid copper bonding jumper shall be required for equipotential bonding in the area of the hydromassage bathtub and shall not be required to be extended or attached to any remote panelboard, service equipment, or any electrode. Where a double-insulated circulating pump motor is used, the 8 AWG or larger solid copper bonding jumper shall be long enough to terminate on a replacement nondouble-insulated pump motor and shall be terminated to the equipment grounding conductor of the branch circuit for the motor. (680.74)